



ROBERT. SOFA

Robert Sofa draws its inspiration from the bold strength of Scotland's skirts, renowned for their history, craftsmanship, and resilience. With a design that mirrors the powerful folds of tradition, the sofa offers both comfort and a striking presence, especially emphasized by the pleated arms. Paying homage to figures like the poet Robert Burns, it speaks to the legacy of Scottish artistry. Each pleat, meticulously stitched, reflects the enduring

AS PICTURED

Upholstery: Cotton Velvet, ref. Vanilla, CV41.

PRODUCT OPTIONS

Upholstery: Available in all Munna fabrics except Leather and Wild Silk. Not available in client's own material.

STRUCTURE FEATURES

Frame in solid wood.
 Upholstery with straps.
 Foam in 100% PU with BS standard fire specifications.
 Foam in American Standard CAL 117 for the USA.
 Fire retardant interlining is available on request.
 Handmade in Porto.

DIMENSIONS

W: 280 cm | 110,24"
 D: 105 cm | 41,34"
 H: 80 cm | 31,49"
 SH: 40 cm | 15,74"
 AH: 66 cm | 25,98"

Suitable for customization.

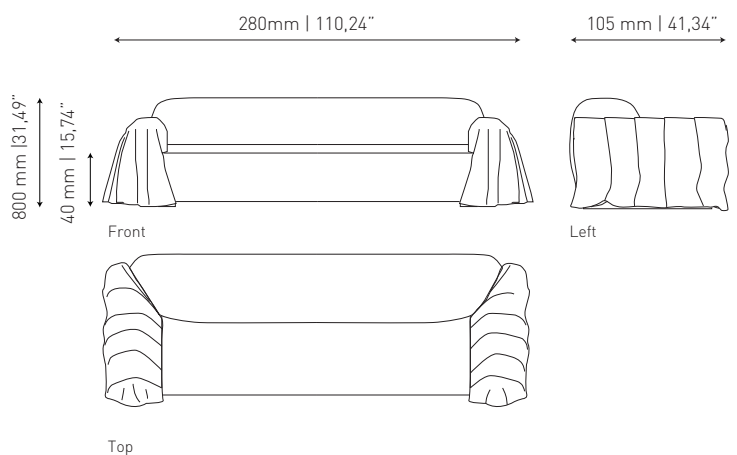

WEIGHT

100 kg | 220 lbs

VOLUME

2,83 m³ | 84 ft³

Packed (in reinforced carton case)

277 kg | 610,68 lbs

3,84 m³ | 135,61ft³

FABRICS

Cotton Velvet
100% Cotton . Martindale 40.000

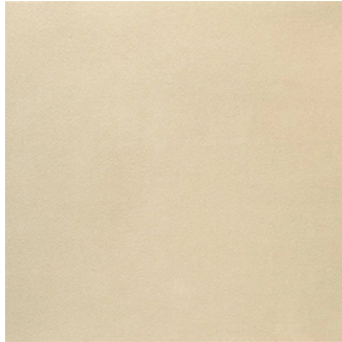

Vanilla



Pale Pink



Camel

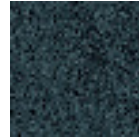

Blue Grey



Teal



Emerald



Buttermilk



Saffron



Red Casino



Lilac



Amethyst

more colours available

Trevira Velvet
100% Trevira CS . Martindale 50.000



Desert

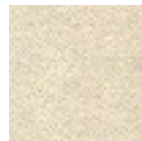

Magnolia



Chocolate



Steel Blue



Teal

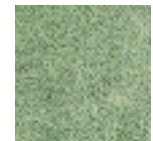

Moss

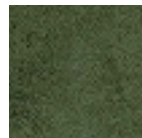

Emerald

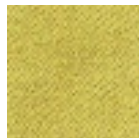

Lime

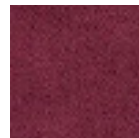

Dark Red



Pale Pink



Antracite

more colours available

Twill FR
53,7% AC + 46,3% PL . Martindale 25.000

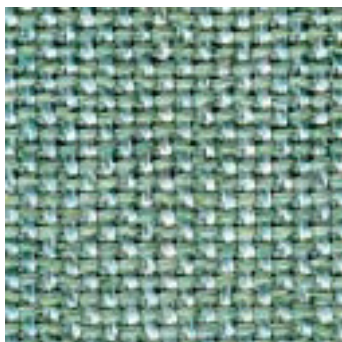

Sky



Magnolia



Desert



Taupe



Black

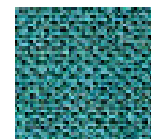

Teal



Lime



Raspberry

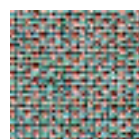

Lilac Green



Silver

FABRICS

Bond Chenille
100% Poliester . Martindale 100.000



Snow

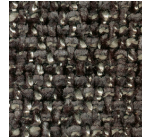

Antracite

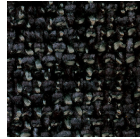

Blue Grey

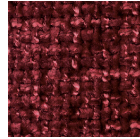

Chilli Pepper

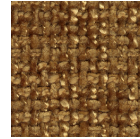

Mustard

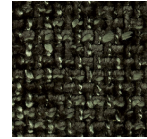

Emerald

Vivid Chenille
54% PL + 42% AC + 4% VI . Martindale 60.000



Saffron



Pure White



Warm Grey



Light Grey



Cloud



Amethyst



Navy



Emerald



Moss



Tangerine Tango



Taupe

more colours available

FABRICS

Bouclé
100% Polyethylene . Martindale 80.000



Sugar

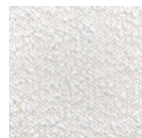

Snow



Desert

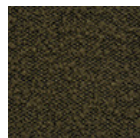

Emerald

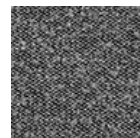

Antracite

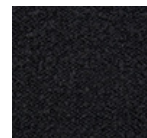

Black